

# ECB-LS2XX Series

## Manual of Split Control Box



Workable distance is up to 200 meters



**Elitech IOT is reliable and safe**

## Safety Regulations

---

- Ⓜ The power of the unit equipped with the electric control box shall not exceed the maximum allowable load
- Ⓜ Please fasten all terminals before electrifying the electric cabinet
- Ⓜ This product must be debugged and installed by professionals
- Ⓜ Non professionals are not allowed to open the electric control box
- Ⓜ General rules for electromechanical installation must be observed
- Ⓜ Connect relevant lines in strict accordance with the wiring terminal diagram
- Ⓜ Before use, the set value of compressor overload current should be adjusted to the corresponding value according to the actual load
- Ⓜ In case of emergency, quickly disconnect the circuit breaker on the electric control box

### Precautions

- Ⓜ The equipment should be placed in a ventilated, dry environment without direct sunlight
- Ⓜ The equipment shall be kept at a proper distance from the condenser and other heat sources
- Ⓜ The sensor and communication line should be wired separately, and keep a proper distance from other strong wires to avoid interference
- Ⓜ For the long-distance normal communication between the main control board and the display board, please use the round network cable with over five specifications (CAT.5E 24AWG) and above, and the maximum limit length is 200 meters.

### Warranty and Exemption Statement

**Warranty period:** The controller is guaranteed for one year from the date of purchase, and the warranty of other original parts is invalid after three months: In case of any of the following circumstances, the warranty is invalid

- a.The use condition is beyond the regulation of this product
- b.Incorrect maintenance
- c.Unauthorized alteration, misuse or artificial damage
- d.There is no purchase and sale certificate for this product

This product is the control equipment of the unit rather than the protection device. If the system, equipment and device used have high safety requirements, please add additional protection device. When users use our company's products in places where personal and property safety is closely related, please adopt special redundancy design to ensure safety. The Company is not responsible for special losses, indirect losses and other related losses caused by our products!

## Main function

ECB-LS2XX series electric control box is an electric control box specially developed by our company for small and medium-sized cold storage. Large screen touch control integrates temperature display, current display and clock display.

- ◆ Smart touch screen: large panel LED screen, clear and intuitive, touch buttons.
- ◆ Multiple networking: Bluetooth, WIFI, 2G and 4G via mobile phones to realize remote monitoring
- ◆ Phase sequence, lack of phase and overload protection function
- ◆ ECB-LS210: dual in-house temperature sensor input, refrigeration and buzzer alarm
- ◆ ECB-LS220: dual in-house temperature sensor input, refrigeration, defrosting and buzzer alarm
- ◆ ECB-LS230: dual in-house temperature sensor input, refrigeration, defrosting, fan and buzzer alarm





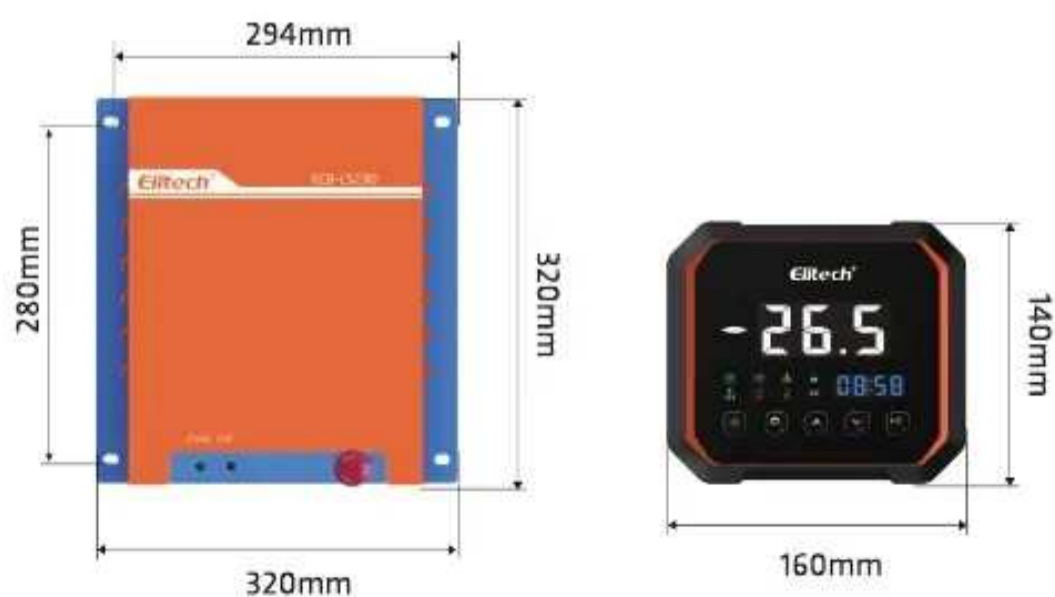

## Technical parameters

<b>Power supply</b>	Three-phase five wire (or three-phase four wire) 380VAC±10%、50HZ
<b>Measuring temperature range</b>	-49°C~-119°C / -56°F~246.2°F
<b>Temperature measurement accuracy</b>	-20°C~50°C±1°C others ±1.5°C; -4°F~122°F ±2°F, others ±3°F)
<b>Temperature control range</b>	-40°C~-119°C / -56°F~246.2°F
<b>Temperature resolution</b>	0.1°C /1°C or 1°F
<b>Current measurement range</b>	2-80A
<b>Current display resolution</b>	0.1A
<b>Accuracy of current detection</b>	±2A (0~30 A), ±5% (within the nominal range of other transformers)
<b>Compressor delay</b>	0-10 minutes
<b>Output capacity of relay contacts</b>	5A/240VAC
<b>Maximum allowable continuous output current of compressor circuit</b>	14A(5P) 21A(10P) 28A(15P)
<b>Maximum allowable continuous output current of defrosting circuit</b>	14A(5P) 21A(10P) 28A(15P)
<b>Maximum allowable continuous output current of fan circuit</b>	7A(5-15P)
<b>Working environment</b>	0°C~40°C
<b>Sensor type</b>	NTC (10KΩ/25 °C, B value 3435 K)
<b>Sensor wire length</b>	3 pcs sensors at 5 m/8 m (including probe length)







## Operation and display panel

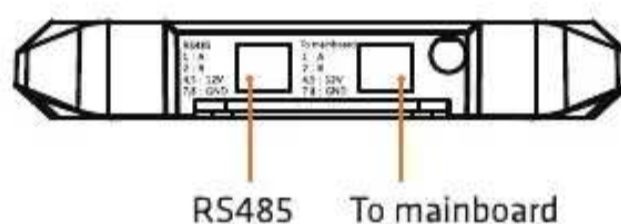

-  Defrosting indicator lamp
-  Refrigeration indicator lamp
-  Fan indicator lamp
-  Unlock indicator lamp
-  Communication indicator lamp
-  Alarm indicator lamp
-  Light indicator lamp
- AUX** Auxiliary indicator lamp



## Operation and display panel









	Long press for 5 seconds and enter the force defrosting mode (defrosting conditions met)/short press and release, enter HACCP alarm view with HACCP function enabled
	Long press for 2 seconds to unlock/short press to enter user settings menu F01/long press to enter system settings menu F06
	Switch parameter code/adjust parameter value/when auxiliary output acts as light, short press to turn on light and short press again to turn off light
	Switch parameter code/adjust parameter value/short press and release to enter temperature view state, P1 display
	Long press for 5 seconds to pause/long press to stop/short press to return/short press to enter clock adjustment state

## Quick operations guide

### • Button unlock

In normal operation interface, the buttons will be locked after 10 seconds without button operation. The button lock indicator lamp is on and no relevant operations can be performed. In case of button lock lamp on, long press  for over 2 seconds to turn off the lamp. Then, the buttons are unlocked and relevant operations are available.





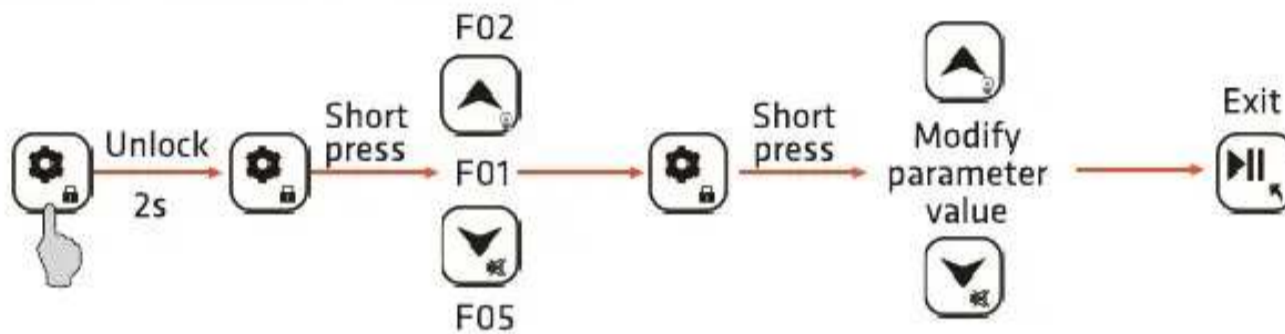



### • User settings menu (F01--F05)

After buttons are unlocked in operation state, short press  and release and control temperature F01 will be shown in the display window. Enter user settings menu, press  or  to switch parameter codes in order. Press  to enter the corresponding parameters and adjust the parameters through  or . After the parameter values are modified, press exit button , to save the modified values and return to parameter code interface. Press  again or do not press any button for 10S to automatically exit from the menu and save the parameters.



### • System settings (F06--F48)

Long press  for over 5 seconds in normal operation state with no button locked;

- (1) In case of no system password setting, follow above procedures for display F06, ①: press  or  to switch parameters and the parameters will be shown through the switch among F06--F48; press  to display the parameter values and adjust the values through  or . Press  or do not press any button for 10S to save the data and return to the parameter item interface. Press  again or do not press any button for 10S to exit from the parameter setting interface and save the modified parameter values.
- (2) In case of system password setting, i.e. F32 value is not 0 and the display window will show PAS. Press  to enter the password parameter value of F32 and then enter system settings menu for F06 display. Follow the procedures of above process ①.

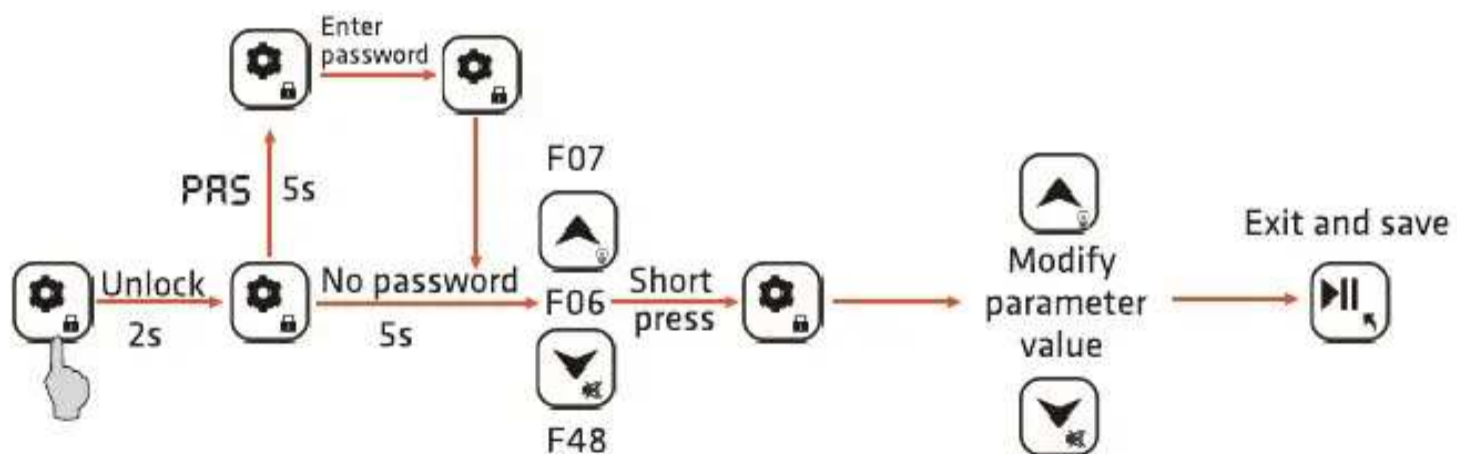

• Force refrigeration

In the non-defrosting, non-refrigeration, non-defrosting or drip, non-compressor shutdown alarm, non-parameter setting or non-parameter view state, in case of the storage temperature larger than shutdown temperature but smaller than startup temperature, press for over 5 seconds to enter the force refrigeration state. The refrigeration indicator lamp flashes when the compress delay is smaller than the set delay time; the indicator lamp is on when the compressor delay is larger than the set time. Remote force refrigeration is available through platform setting;

• Force defrosting:



Long press for 5 seconds with no button locked and no defrosting, then the system enter force defrosting state with defrosting conditions met. In defrosting state, long press force defrosting button to exit from defrosting state and enter defrosting drip state. Remote force defrosting is also available through platform setting;

• Clock setting

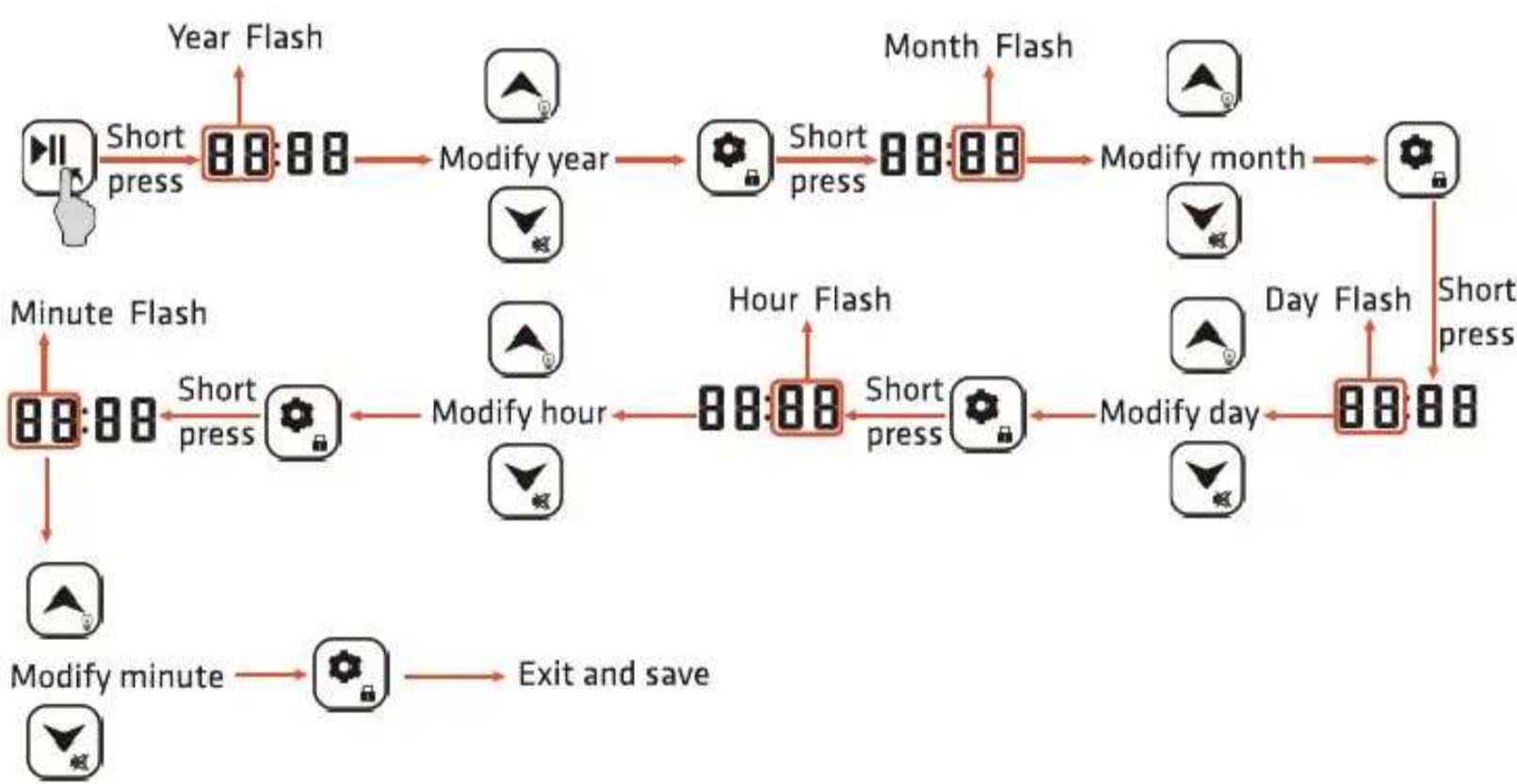





In case of large difference between the clock and actual time in normal operation state with no button locked, time can be adjusted through setting. The detailed method is as follows: short press and the year number flashes to enter the clock adjustment state. Press or to increase or decrease the year number and press button to save the year number. Then the month number flashes. Press or to increase or decrease the month number and press button to save the month number. Then the day number flashes. Press or to increase or decrease the day number and press button to save the day number. The hour number flashes. Press or to increase or decrease the hour number and press button to save the number. Then the second number flashes. Press or to increase or decrease the second number and press button to save the number and exit from clocking setting. In case of no operation for 10S in time setting interface, the system will automatically exit from the interface. Time can also be adjusted through mobile phone APP or remote control of the platform;



• Startup and shutdown setting

In normal operation state, long press  for over 5 seconds and the display will show PAC. The system will be in operation suspension state, which is subject to F44 setting time. Then, the system will operate normally. In the suspension state, long press  for 5 seconds to show OFF. The system is off. OFF on the screen means shutdown of the controller as well as all outputs. Long press  for over 5 seconds and the system will operate normally; remote startup and shutdown are available through platform setting.

• **View temperature and current parameters**

In normal operation state with no button locked, short press and release  to display P1 and enter the temperature view interface. Switch P1~P9 through  or . Press  to enter corresponding temperature view interface during the display of P codes. Press  or  again to return to P codes interface. In the interface, short press  to exit from temperature view interface; P1: main storage temperature; P2: defrosting probe; P3: alternative sensor; P4: phase A current; P5: phase B current; P6: phase C current; P7: average current; P8: reserved; P9: reserved.

## Compressor

• **The following conditions shall be met for normal startup of the compressor:**

- ① The equipment starts normally without startup delay of compressor
- ② The equipment is not in defrosting or drip mode
- ③ There is no pressure control alarm or probe failure
- ④ The storage temperature is no smaller than the Start-up temperature; or the hot gas defrosting starts
- ⑤ The time after startup of magnetic valve is no smaller than V01 (in case of F47=1). **This item is only valid with the negative pressure function is started**

Other: The storage temperature is no smaller than the Start-up temperature F02+C05 (the compressor starts up when the night energy-saving mode is enabled with above ①②③⑤ conditions met). **The relation is only valid with the night energy-saving mode enabled.**

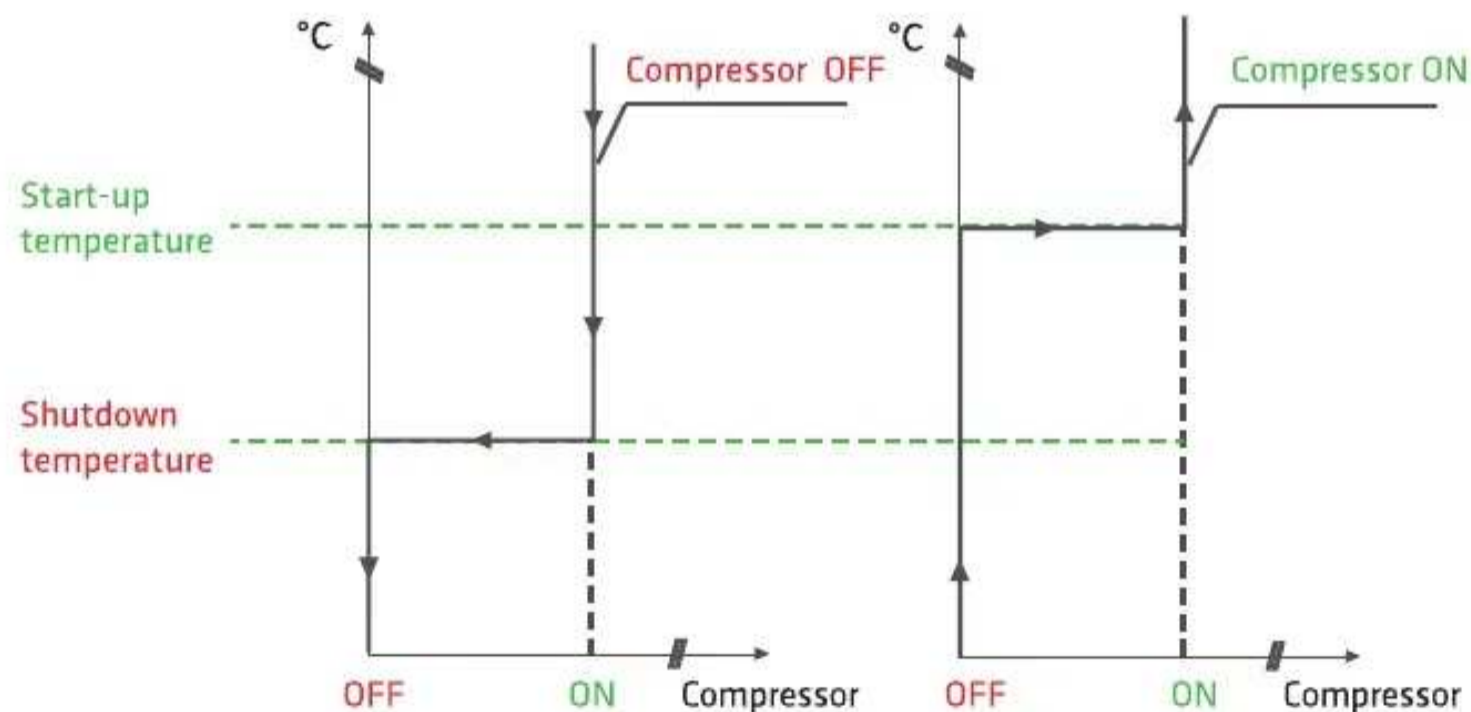

• **Basic protection of compressor:**

The startup and shutdown of compressor shall be subject to a certain time interval. ❄️ Flashing on the

panel means that the equipment has received the compressor startup request, but the compressor is still under protection and will start after the protection time expires. Users can set the safe startup / shutdown time for compressor through below parameters.

**Minimum startup time - F08**

The minimum working time after startup of compressor;

**Minimum shutdown time - F09**

The minimum shutdown time between two startups of compressor;

**Powered initial startup delay - F11**

When the equipment is power on, it can start up after F09 and F11 protection time. The overall protection time is not the sum of the two protection time, but the longer one. Compressor can only start up after the longer protection time.

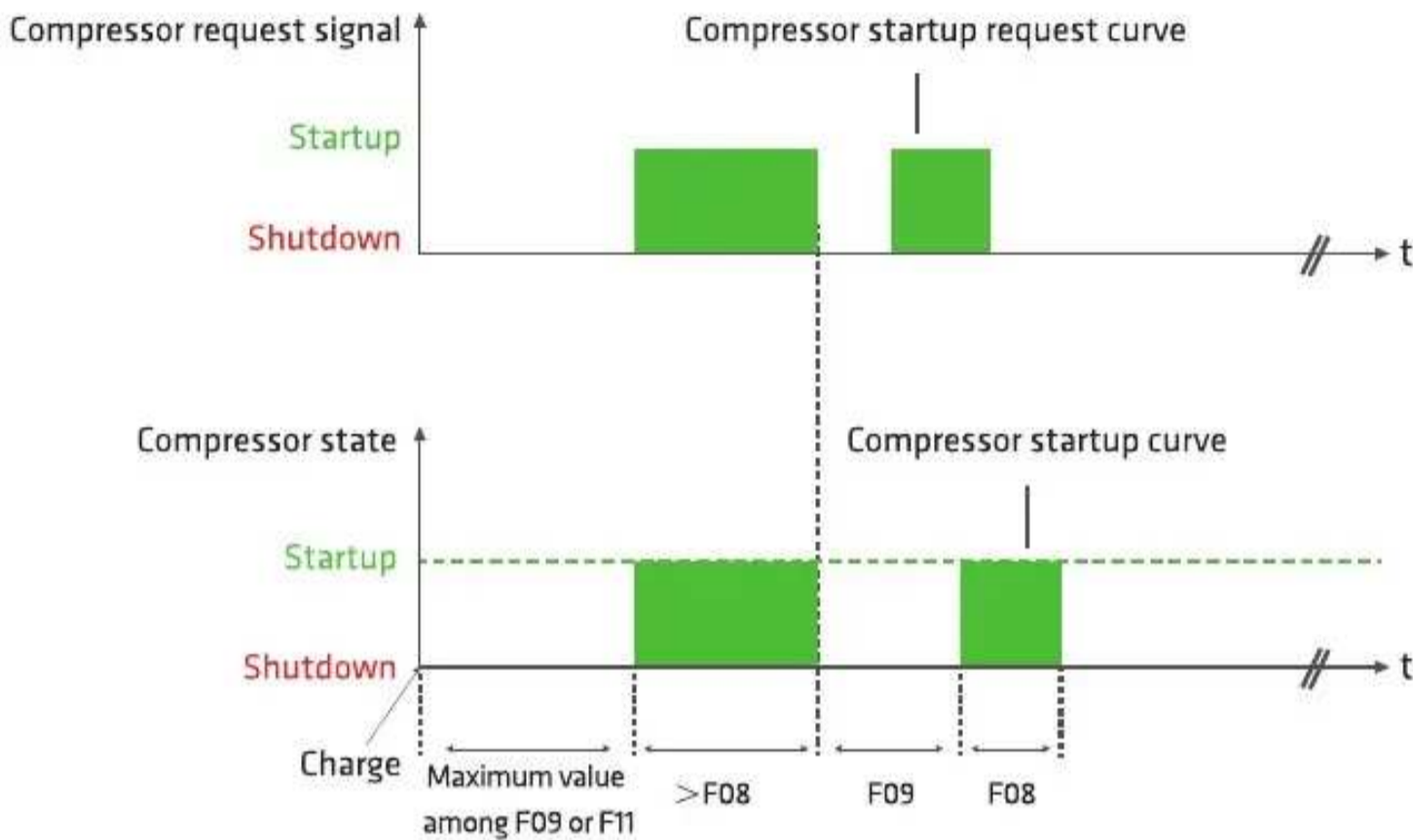

**Defrosting**

• The following conditions shall be met to start the defrosting function

- ① Defrosting cycle F03 > 0
- ② Defrosting time F04 > 0
- ③ Defrosting measurement temperature < defrosting termination temperature F05

The defrosting function will stop where any condition above is not met.

Attention:

F20 defrosting type (1: electric defrosting 2: hot gas defrosting) **electric defrosting by default**

F21 defrosting sensor (0: disabled 1: enabled) **enabled by default**

F22 defrosting drip time (0-20)min **3 minutes by default**

F23 powered initial defrosting delay (0-99)min **0 minute by default**

F24 defrosting sensor calibration (-12.0--12.0)°C/(-21.6--21.6)°F **0 minute by default**

F25 defrosting cycle timing method: 0: controller working time; 1: compressor accumulation time  
**controller working time by default**

F26 display mode during defrosting: 0: measurement value of actual storage temperature sensor; 1:



F26 display mode during defrosting: 0: measurement value of actual storage temperature sensor; 1: measurement value of the storage temperature sensor at the beginning of defrosting cycle; 2: deF; 3: settings **deF display of temperature default**

F27 defrosting startup mode (1: cyclical defrosting; 2: real-time clock defrosting) **cyclical defrosting by default**

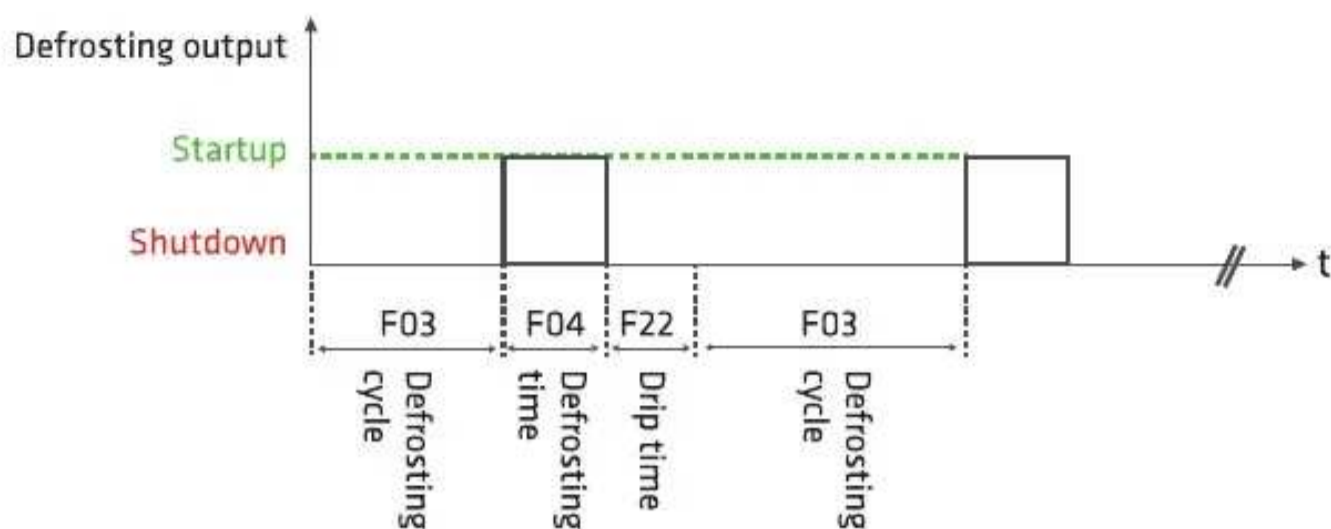

• **Defrosting drip time F22:**

After defrosting, there may be water on the surface of evaporator. Refrigeration at such a moment will lead to icing on the surface of evaporator. Therefore, some time shall be spared to allow the water to flow away, which is called the drip time.

• **Real-time defrosting:**

Please refer to below real-time clock defrosting parameters.

**Fan**

Fan startup F28 in non-defrosting state	-1~-30	Fan starts up 1-30 minutes earlier than compressor	0 by default, simultaneous startup
	0~30	Fan starts up 0-30 minutes later than compressor	
	C	Fan operates continuously	
Fan shutdown F29 in non-defrosting state	0~30	Fan shuts down 0-30 minutes later than compressor	0 by default, simultaneous shutdown
	C	Fan operates continuously	

In defrosting state, when F30=1, the fan shuts down; when F30=2, the fan starts up.

**Operation of alternative sensor and compressor**

In normal operation state, in case of alternative sensor enabled, it will be applied for temperature control when the main storage temperature sensor fails to work. In case the alternative sensor fails as well, the

compressor shall be subject to operation of 15 minutes and shutdown of 30 minutes for several times; in case of alternative sensor disabled, the compressor shall still be subject to operation of 15 minutes and shutdown of 30 minutes for several times.

### Door switch function

In case of door switch function enabled and when the product is power on, the current door switch frequency state and open time are available to be uploaded to the cloud platform through the pipe-line communication module without local data storage. Above data shall be re-counted when the product is power off and on again.

### Water pump control (F39=4)

When refrigeration function starts, open water pump at first and start the compressor after the water pump has completed the prefilling time set. When refrigeration stops and the compressor shuts down, the water pump shuts down after the set shutdown delay rime.

### Alarm output

In operation state, when any of the following conditions occurs and the parameter F18=2 with the buzzer ringing and alarm relay operating, it is available to press and release any button to eliminate the ringing of buzzer.

- Special note: The high temperature alarm means the storage temperature is no smaller than the control temperature F01+F02+F13. In case of powered initial high temperature alarm or initial alarm after defrosting, the high temperature alarm occurs when the alarm time exceeds F17; in case it is not the initial high temperature alarm and occurs when the duration is no smaller than F16, the fault code E5 and current storage temperature will be alternatively shown in the temperature display window. When the storage temperature of is smaller than the control temperature F01+F02+F13-F15, the alarm will be eliminated.
- Special note: The low temperature alarm means the storage temperature is smaller than the control temperature F01-14. In case of powered initial alarm, the low temperature alarm occurs when the alarm time exceeds F17; in case it is not the initial alarm and its duration no smaller than F16, the low temperature alarm occurs and the fault code E6 and current storage temperature will be alternatively shown in the temperature display window. When the storage temperature is larger than the control temperature, the alarm will be eliminated.
- Note: High and low temperature alarms will not occur in defrosting state and with door switch on;

### Alarm code

Code	Content
E1	Short circuit of storage temperature probe

Code	Content
E11	Failure of alternative sensor

	temperature probe
E2	Open circuit of storage temperature probe
E3	Short circuit of defrosting probe
E4	Open circuit of defrosting probe
E5	High temperature alarm
E6	Low temperature alarm
E7	Door switch alarm
E8	Man in cold storage alarm
E9	External alarm
E10	Pressure protection alarm

	sensor
E12	phase sequence alarm
E13	Unbalance protection
E14	phase sequence protection
E15	Unbalanced protection
E16	Open-phase protection
E17	Low humidity (reserved)
Err	Communication error between display board and mainboard

### Probe or temperature alarm

In the running state, when the following situations occur and the parameter F18=2, the buzzer will sound and the alarm relay (F39=1) will pull in and close at the same time. Press and release any key to eliminate the buzzer alarm sound.

- 1) When the temperature probe is short-circuited, the fault code E1 will appear on the screen
- 2) When the temperature probe is, the fault code E2 will appear on the screen.
- 3) When the defrosting probe is short-circuited, the screen will display fault code E3 and current temperature
- 4) When the defrosting probe is disconnected, the screen will display fault code E4 and current temperature
- 5) When two probes fail at the same time, the screen displays the fault code alternately.
- 6) High temperature alarm: When the temperature is  $\geq F02+F13$ , if it is the first high-temperature alarm after power-on or defrosting, a high-temperature alarm will be generated when the alarm time exceeds F17. If it is not the first alarm and a high temperature alarm will occur when the alarm time is  $\geq F16$ , the fault code E5 and the current temperature will be displayed alternately on the screen. When the temperature is greater than  $F02+F13-F15$ , the alarm will be eliminated.
- 7) Low temperature alarm: When the temperature is  $< F01-F13$ , if it is the first alarm of power-on, a low temperature alarm will be generated when the alarm time exceeds F17. If it is not the first alarm and a low temperature alarm will occur when the alarm time is  $\geq F16$ , the fault code E6 and the current temperature will be displayed alternately. When the temperature is greater than the control temperature, the alarm is eliminated.

*Attentions: Under the conditions of defrosting and opening the door switch, no high and low temperature alarm will be generated. the screen will display fault code E3 and current temperature.*

### Unit comprehensive protection (F45=1 enabled)

Except for phase sequence protection, other current protections follow the following time to generate protection function. After the protector is powered on, no current protection action occurs within U07 time. When the load is started, no current protection action occurs within U09 time. U10 parameter determines the selection of average current.

1. Open-phase protection

Under the condition of compressor output, when U13=1, when the average current exceeds 2 A, if any phase current drops to 0 and the duration is greater than or equal to U08, if the current is still 0, the open-phase protection will be generated, E16 will be displayed, and the system will cut off the output.

### 2. Overload protection

When U11=1, when the average current is  $\geq U01$  (overload current setting), the influence of protection action time U02 (overload protection inverse time function) and U06 (overload current protection delay start time). When U02=0, the Inverse-time over-current protection function is not enabled. Protection time=U06. When U02=1, the inverse time function is enabled. During protection= $U06/[(\text{average current}-U01)/2]$ . The larger the average current exceeds the set protection current, the faster the protection action time is, and the unbalanced protection is. Overload protection alarm code E13.

After overload protection occurs, the protector automatically resets after 5 minutes, and the fault code of the protector disappears after resetting.

If the number of consecutive resets within half an hour is greater than U03 (the number of automatic resets after overload protection), the protector will not reset automatically, and can be reset only after the protector is powered off and restarted.

### 3. Unbalanced protection

When U04 is not equal to 0, the maximum current phase minus the minimum current phase is greater than or equal to the current value of U04 (three-phase unbalanced protection current setting), and the duration exceeds U05 (unbalanced protection delay) time. The three-phase unbalance protection acts, the screen displays E15 fault code alternately, and the buzzer sounds. In case of this protection, the protector needs to be powered off to restart and reset the protection function.

## Phase sequence protection

When F46=1, the system enables the phase sequence protection function, and the wiring is performed according to the requirements shown in the instrument wiring diagram. After the instrument is powered on, if the phase sequence is wrong, alarm E14 and turn off all outputs. Phase sequence protection shall be detected within 2 minutes after the instrument is powered on, and shall not be detected after 2 minutes.

## Instruction of Optional Networking

LS-2XX has three networking modes: WIFI/2G/4G/Bluetooth. Users can choose three networking selection modes (i.e. WIFI+Bluetooth/2G+Bluetooth/4G+Bluetooth/Bluetooth) according to their needs.

### Preparatory work

- 1) Before configuring networking operation, power-off operation shall be carried out on the equipment.
- 2) Insert the SIM card first, if 4G networking is required.

Please connect your mobile phone to the WIFI that you need to use first, if WIFI networking is required.

Please turn on the Bluetooth of your mobile phone first, if Bluetooth networking is required.

3)Download the "Elitech iCold" app from the mobile app store.

## WIFI Networking Configuration Operations

### • Register and login

Please register for the first time according to Step 1 and follow the instructions to operate on the registration window.

Please fill in your registered name and password, and follow steps 2-4 in the figure below.

Follow the instructions.



12

### • Add your device

Click "+" to add your device after logging in and operate as instructed in Step 5 in the following picture.



- 1) Add device GUID
- 2) Scan QR code to add your device, as shown in Step 6 of the figure below; Or manually enter GUID (20 bits), as shown in Step 7 of the following figure;
- 3) Customize the device type name, as shown in Step 8 of the figure below;
- 4) Click the "add now" button, as shown in Step 9 of the figure below;
- 5) Press the "add now" button in the pop-up window, and then click OK.



 Note: The QR code and GUID are at the top left of the device.

#### • Enter the WiFi password

The following window pops up after Step 9. Enter the WiFi password connected to the mobile phone at Step 10, and then power on the device. Operate Step 11 in 5 seconds later, and the page will pop up the window "connecting to the network".

The connection process takes about 5 ~ 30 seconds.

Click Return and the home page will display the device online after the networking configuration.





### Note:

1. Please power off the device first, and then repeat steps 5 ~ 11 if the device fails to connect to the network.
2. WIFI configuration needs to be completed within 2 minutes after the device is powered on. If it exceeds 2 minutes, it is required to disconnect the device for 1 minute, then switch on the power and reconfigure WIFI networking.

## 4G Networking Configuration Operation

If the device has been successfully added, the network does not need to be configured again, and the SIM card can be directly plugged in to automatically connect to the network.

Configure 4G networking according to the following steps, if the user adds a device for the first time.

### • Configuration of mobile terminal to 4G networking

Refer to Steps 1-9 in the WIFI Configuration.

Automatically exits the configuration page after networking completed, and the home page will show that the device is online

### • Web-side configuration networking

#### Login Account Number

Open the browser, enter the website of Elitech website- [www.i-elitech.com](http://www.i-elitech.com) in the address bar, fill in the user name and password, and click Login. Follow steps 1-5 in the following figure. Click the left corner to register first, and follow Steps 2-5 after registration.



### Add device

Click Project Center >> Default Project >> Add Device in turn, and follow Steps 6-8 in the following figure after logging in.



Then, enter the GUID of the device to be networked and defined device name on the information window popping up for Add Device, and then click Next. Follow Steps 9-11 in the following figure.



Select the default project and click next. Follow Steps 12-13 in the following figure.

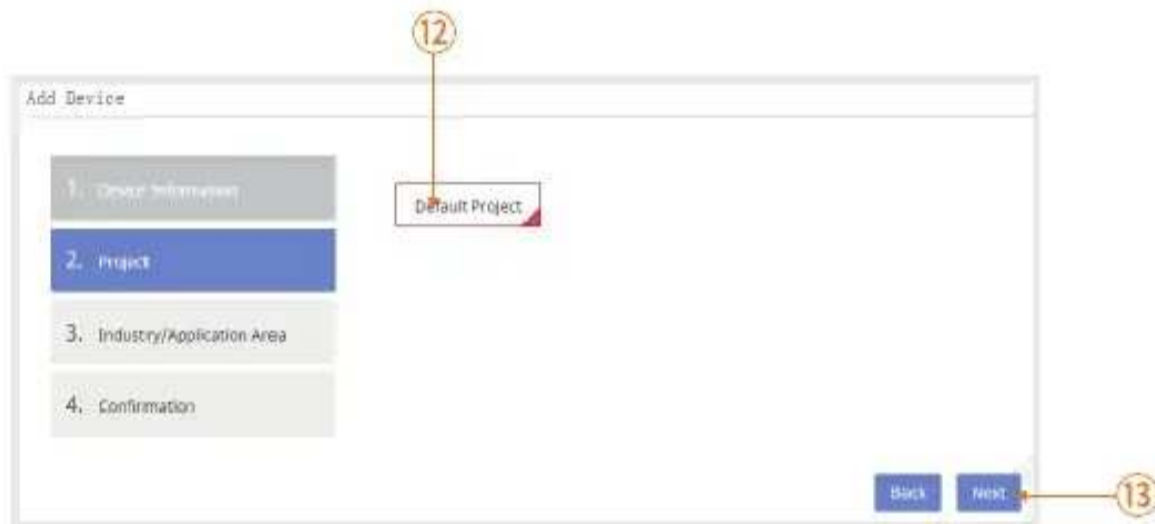

Select the device usage scenario and click next. Follow steps 14-15 in the following figure.

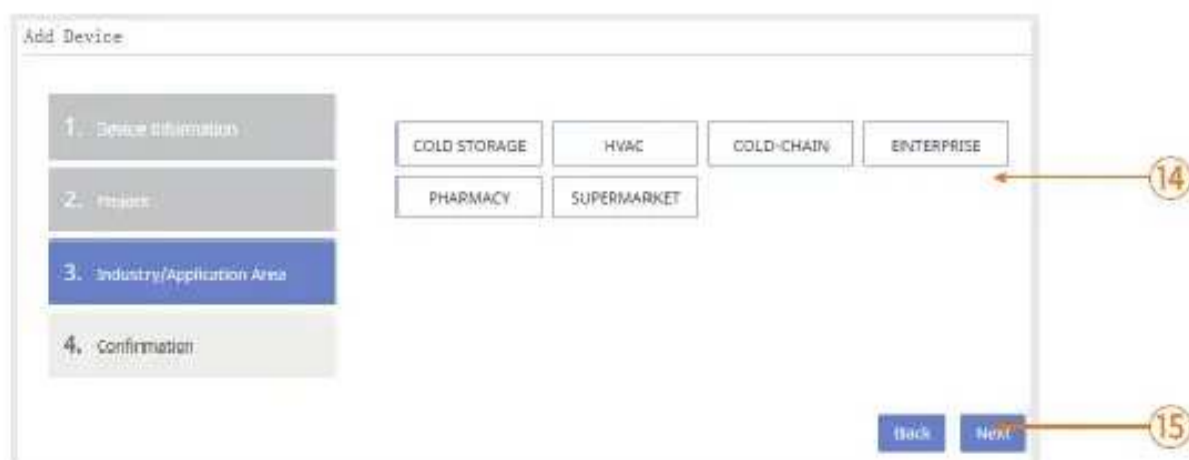

Display the information added by the device, and click Finish after confirming it is correct. Follow Step 16



of the figure below.

Add Device

1. Device Information
2. Project
3. Industry Application Area
4. Confirmation

ID: 084391709d34548f460f

Device Name: 1

Time Zone: GMT+08:00|Beijing

Project: Default Project

Trade: COLD STORAGE

Back Finish 16

Refresh the page after device added and display the added devices.

### WiFi Reset Operation

Press and display P1 for a short time, in the non-key locking state, after the equipment is powered on. Press or to search and display P6 for many times, press for a short time and temperature display box will display the WiFi connection status number at this time. Press for 5 seconds in this state, and a reset rst will occur. At this time, no key needs to be pressed, and the WiFi reset is completed when it is converted to the temperature display state.

Note: After reset operation, it is recommended to restart the device. Find P6 in the lower part, which is the WiFi signal status and shows 34 as the WiFi connection is successful.

### SIM Installation

Power off the device before inserting the SIM card.

## Bluetooth Networking Configuration Operation

Search and download the "Elitech iCold" app in the mobile app store, install it, turn on the Bluetooth function of the mobile phone, power up the controller, and turn on the APP.



Click on the upper left corner of the homepage of the page, wait until the left picture appears, and



select the Bluetooth controller

Open the positioning according to the prompt.



Click here to connect to the product. On this page, if you short press the defrost button on the controller, a red background will display a prompt. This function is used to identify the device when multiple devices are not connected

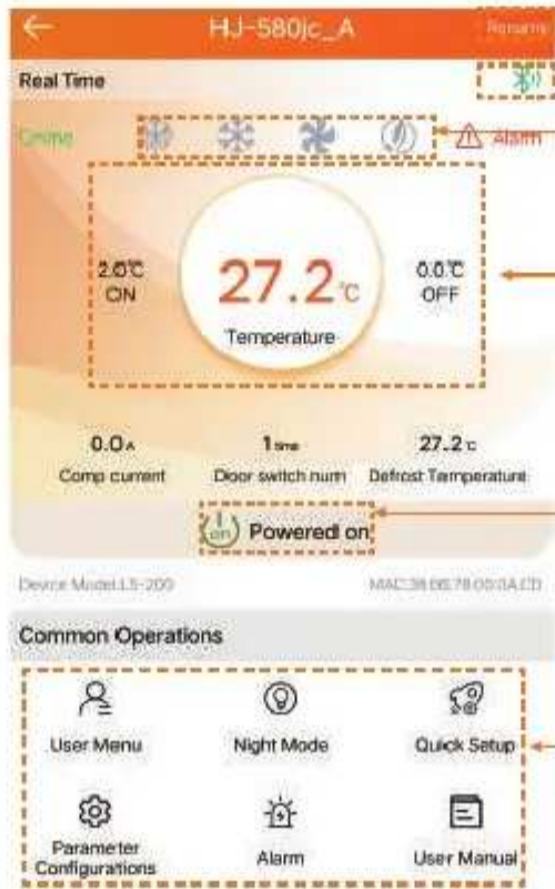

Click to modify the name

Click to disconnect the Bluetooth connection

Display output status

Display real-time temperature and start and stop temperature

Switching equipment

Can be set

**The basic function parameter codes are as follows:**

Menu	Menu functions	Scope	Default value
F01	Start-up temperature	(-49...F02-1)°C/(-56...F02-1)°F	0.0
F02	Stutdown temperature	(F01-1...100)°C/(F01...212)°F	2.0°C/3.6°F
F03	Defrosting cycle	(0...48) h	6
F04	Defrosting time	(0...99) min	30
F05	Defrosting termination temperature	(0...99.0)°C/(0..210)°F	8.0°C/36.4°F

**The extended function parameter codes are as follows:**

Men	Menu functions	Scope	Default value
-----	----------------	-------	---------------

u	Menu functions	Scope	Default value
F06	-----	-----	spare
F07	-----	-----	spare
F08	Minimum startup time	(0...15) min	0
F09	Minimum downtime	(0...15) min	0
F10	Temperature correction for main sensor	(-12.0...12.0)°C/ (-21.6...21.6)°F	0.0
F11	Initial power-on start delay	(0...30) min	2
F12	Energy saving mode at night (1: on, 2: off), specific C parameter	(1...2)	2
F13	High temperature alarm: Start-up temperature+F13	(0...30)°C/(0...54)°F	10°C/18°F
F14	Low temperature alarm: shutdown temperature-F14	(0...30)°C/(0...54)°F	10°C/18°F
F15	Alarm backlash	(1...10)°C/(1...18)°F	2°C/3.6°F
F16	Alarm delay	(0...99)min	30
F17	First alarm delay after power-on or defrosting	(0...99)min	20
F18	The buzzer is off for alarming (1: on and 2: off)	(1...2)	1

F19	Door switch alarm delay	(0...120)min	30
F20	Defrosting type (1: electric defrosting, 2: hot gas defrosting)	(1...2)	1
F21	Defrosting sensor (0: disable, 1: enabled)	(0...1)	1
F22	Defrosting dripping time	(0...20)min	3
F23	Initial power-on defrosting delay	(0...99)min	0
F24	Defrosting sensor correction	(-12.0...12.0)°C/ (-21.6...21.6)°F	0
F25	Timing mode of defrosting period: 0: working time of controller; 1: compressor accumulation time	0-1	0

F26	Display mode during defrosting: 0: Display actual warehouse temperature sensor measurement value; 1: Display the measured value of the warehouse temperature sensor at the beginning of defrosting cycle; 2: Display deF; 3: Display set temperature	0-3	2
F27	Defrosting start mode (1: Cycle defrosting, 2: Real time clock defrosting)	(1..2)	1
F28	-30~-1: The fan starts 1-30 minutes earlier than the compressor 0-30: The fan lags to start for 0-30 minutes later than the press; C: Continuous operation	(-30...30..c)	0
F29	Fan shutdown mode: 0 ~ 30: the fan lags behind the compressor for 0 ~ 30 minutes to shut down; C: Continuous operation	(0...30...c)	0
F30	The fan stops running during defrosting (1: Yes, 2: No)	(1..2)	1
F31	Alternate sensor selects 0: not enabled; 1: Enable (see parameter b for details)	(0...1)	1

F32	Parameter entry password	(0...999)	0
F33	Decimal display (1: Yes, 2: No)	(1..2)	1
F34	Fahrenheit display (1: Celsius, 2: Fahrenheit)	(1..2)	1
F35	Definition of digit set 1 function; 0: shield; 1: defined as defrosting; 2: auxiliary input; 3: door switch; 4: external alarm; 5: pressure switch; 6: People alarm in the cold storage,	0-6	5
F36	Digital quantity 2 function definition; 0: shield; 1: defined as defrosting; 2: auxiliary input; 3: door switch; 4: external alarm; 5: pressure switch; 6: People alarm in the cold storage,	0-6	5

F37	Selection of digital quantity 1 type input (0: Normally closed valid, 1: Normally open valid)	0-1	1
F38	Digital set 2 type input selection (0: Normally closed valid, 1: Normally open valid)	0-1	1
F39	Definition of alarm relay function; 0: Shielding; 1: Alarm output; 2: auxiliary output; 3: light relay; 4. Output of condensate pump;6: solenoid valve output (negative pressure shutdown)	0-6	1
F40	Door switch input purpose: 0: compressor and evaporation fan are closed; 1: Close evaporation fan; 2. Turn on the storehouse lamp; 3. The compressor and evaporation fan are closed and the warehouse lamp is turned on; 4. The evaporation fan is turned off and the warehouse lamp is turned on;	0-4	2

Note: When F47=1, F39 is automatically set to 6; In the default parameter state, F36=5.

F41	Pre-filling time of water pump	3~255 sec	3
F42	Water pump shutdown delay	3~255 sec	5
F43	Allowable number of alarm times of pressure switch (within 15 minutes). If this value is exceeded, the compressor will no longer be turned on and needs to be restarted without power supply.	1-5	3
F44	Current protection function: 0: not enabled. 1: enabled	1-120 min	30
F45	Current protection function: 0: not enabled. 1: enabled	0-1	0
F46	Selection of phase sequence		0

F46	Auto defrost phase sequence function: 0: closed. 1: open	0-1	0
F47	Negative pressure shutdown function: 0: Off; 1: On; See the following parameter setting V parameter for details	0-1	0
F48	RS485 mailing address	1-127	1

• **Clock defrosting parameter (enabled when F27=2, press  to enter this menu operation)**

No.	Parameters	Parameter setting description	Scope	Default value
1	d01	1st defrosting start hour	(0...23)hour	0
2	d02	1st defrosting start minute	(0...59)min	0
3	d03	2nd defrosting start hour	(0...23)hour	0
4	d04	2nd defrosting start minute	(0...59)min	0
5	d05	3rd defrosting start hour	(0...23)hour	0
6	d06	3rd defrosting start minute	(0...59)min	0
7	d07	4th defrosting start hour	(0...23)hour	0
8	d08	4th defrosting start minute	(0...59)min	0
9	d09	5th defrosting start hour	(0...23)hour	0
10	d10	5th defrosting start minute	(0...59)min	0
11	d11	6th defrosting start hour	(0...23)hour	0

11	d11	6th defrosting start hour	(0...23)hour	0
12	d12	6th defrosting start minute	(0...59)min	0
13	d13	7th defrosting start hour	(0...23)hour	0
14	d14	7th defrosting start minute	(0...59)min	0
15	d15	Maximum defrosting times per day for same time	0-7	0

• Energy saving mode at night parameter (enabled when F12=1, press  to enter this menu)

S/N	Parameters	Parameters setting description	Range	Default value
1	C01	Start hours of night energy saving mode	(0 ...23)hour	22
2	C02	Start minutes of night energy saving mode	(0 ...59)min	0
3	C03	End hour of night energy saving mode	(0 ...23)hour	8
4	C04	End minutes of night energy saving mode	(0 ...59)min	0
5	C05	Change value of set point of night energy saving mode	(-10 ...10)°C/°F (-18 ...18)°F	2.0°C /3.6°F

• Related parameters of Backup sensor (enabled when F31=1, press  to enter)

No.	Parameters	Parameter setting description	Scope	Default value
1	b01	Channel 3 sensor function setting; 1. After the failure of the warehouse temperature sensor, the sensor is automatically used to control the temperature; 2. It is used as a warehouse temperature sensor, only for measurement, not for control; 3. It is used together with the storehouse temperature sensor to control the start and stop of the compressor at the average temperature.	1-3	1
2	b02	Standby sensor temperature correction	(-12.0...12.0)°C/(-21.6...21.6)°F	0
3	b03	High temperature alarm value of standby sensor	(b04-120)°C/(b04-248)°F	50°C/122°F

4	b04	Low temperature alarm value of standby sensor	(-50-b03)°C/(-58-b03)°F	-20°C/-4°F
5	b05	Over-temperature alarm delay for backup sensor	0-120min	30

• **Negative pressure shutdown function parameter menu-V menu (enabled when F47=1, press  to enter)**

No.	Parameters	Parameter setting description	Scope	Default value
1	V01	Solenoid valve advances compressor start time	1-255 sec	30 sec
2	V02	Maximum lag solenoid valve stop time of compressor	1-255 sec	200 sec
3	V03	The 2rd channel digital value switch type (0: valid when normally closed valid; 1: valid when normally open) is used for low voltage switch detection.	0-1	0

• **Current protection function menu (enabled when F45=1, press  to enter this menu to operate)**

S/N	Parameters	Parameters setting description	Range	Default value
1	u01	Overload current setting	2-80	20A
2	u02	Inverse-time over-current protection function 0=disabled. 1=start up	0-1	1
3	u03	Automatic reset times after overload protection	0-3	0
4	u04	Three phase unbalance protection current setting	0~90 A	10
5	u05	Unbalanced protection delay	1~99 S	0
6	u06	Delay starting time of overload current protection	1~99S	3
7	u07	Delay starting time of current protection function after power on	0~9 MIN	1



8	u08	Delay starting time of open-phase protection	1-7S	3
9	u09	After detecting the current, the current protection function delays the start-up time	1-5S	1
10	u10	The average current select 0=A phase. 1=A and B phases 2=A, B and C phases	0-2	2
11	u11	This load protection function 0=disabled. 1=start up	0-1	1
12	u12	Reserved	0-2	2
13	u13	Current open phase function 0 = disabled. 1=start up	0-1	1

## Wiring Diagram

### ECB-LS210

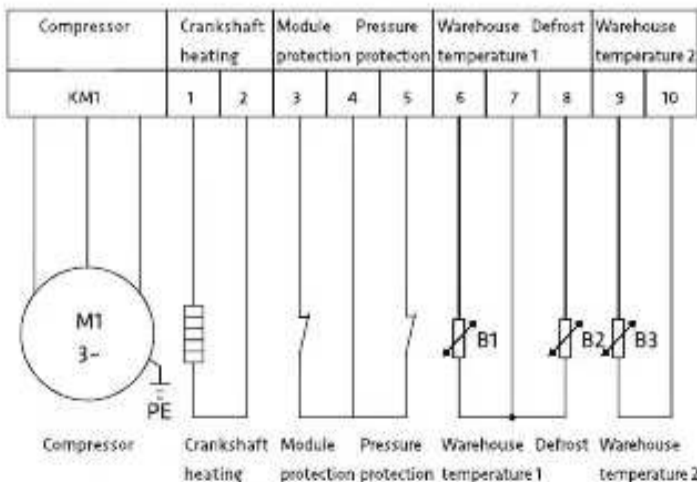

### ECB-LS220

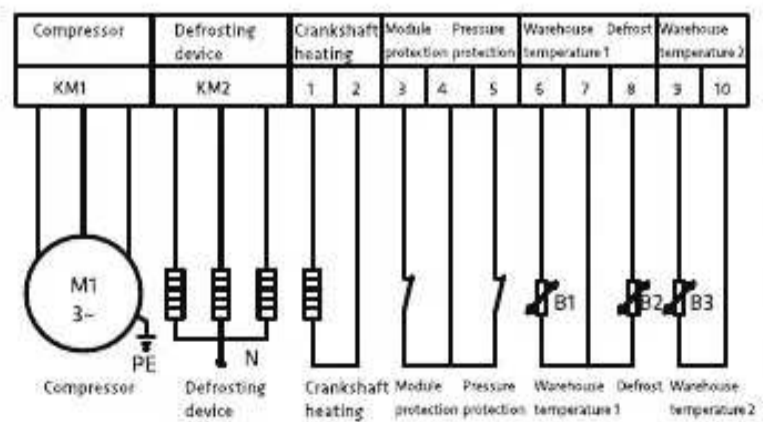

### ECB-LS230

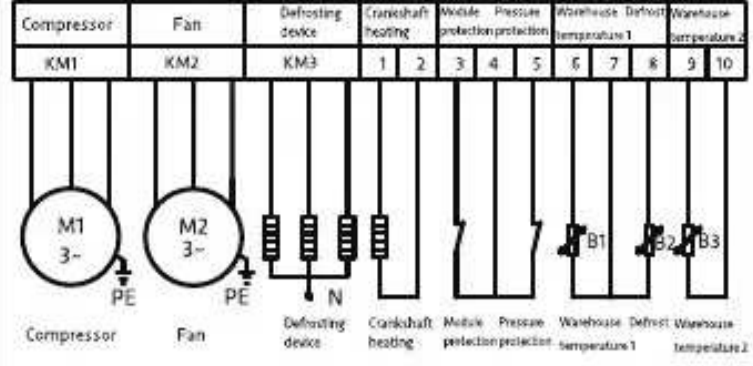

Appendix. Character Set

0	1	2	3	4	5	6	7	8	9
A	b	C	d	E	F	G	H	-	J
K	L	M	n	o	P	q	r	S	T
U	V	W	X	Y	Z	.	-		